

Operating and Installation Instructions

This Product is Protected by U.S. Patent 8388322

CAUTION!

This product is to be installed only by persons knowledgeable in the repair and modification of vehicle fuel systems and general vehicle systems modification. Only a qualified technician or mechanic who is aware of applicable safety procedures should perform the installation of this product.

This fuel pump utilizes an electronic DC motor system that is not typical of conventional fuel pumps, and therefore extra precautions must be adhered to as contained in instructions herein.

GASOLINE AND OTHER FUELS ARE FLAMMABLE AND CAN BE EXPLOSIVE!

Perform the installation in a well ventilated location only to minimize the build up of fuel vapors. NO open flames, smoking or other sources of ignition are to be present during installation, to prevent fire or explosion that can cause serious injury or death. Grinding, cutting, and drilling must be performed with care to prevent ignition. Draining and removal of all fuel and ventilation of vapors in vehicle and fuel system is recommended when performing such procedures. Proper eye and personal protection is required at all times during installation.

WARNING!

The Vehicle's fuel system may be under pressure! Do not loosen any fuel connections until relieving all fuel system pressure. Consult an applicable service manual for instructions to relieve fuel system pressure safely.

This product is intended for racing, off-road, or marine use only. This fuel system component may not be legal for sale or use on emission controlled motor vehicles; consult local, state and national laws.

Product Contents:

Check the diagram and list of components (right) to ensure that no components are missing from box. Contact your Fuelab distributor immediately for replacement.

92902 (-sp) Features and Performance Ratings:

Outlet Port Size	-8AN Military Port
Rated Flow Rate	190 GPH @ 45 PSI, 13.5V (720 LPH @ 3 Bar)
Maximum Pressure	100 PSI (6.8 Bar)
Operating Voltage	8-18 Volts

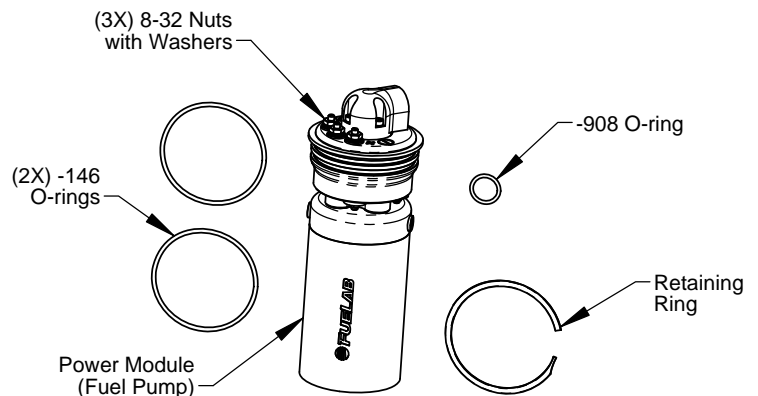

WARNING! Power Supply Voltage must be constant as specified in above specification. Only install fuel pump on vehicles using 12 Volt (6 cell lead acid battery) with a normal operating alternator charging system or vehicles using 16 Volt (8 cell lead acid battery). Pulse-Width Modulation or other means of reducing input power voltage may result in erratic or non-operational condition. Electronic Power Supplies have not shown to be a problem with normal operation, however testing has not been performed on all systems. Consult these instructions on using pulse width modulated frequencies for means of fuel pump speed control.

Before Installation, Plan Entire Fuel System:

A complete design plan of entire fuel system must be created for the specific application. These instructions are a guide to help design this plan with respects to integrating this model of Fuel Pump only. Consult other sources of information and manufacturers' instructions for the various components of the fuel system. These instructions are limited to general topics of Fuel Pump installation and may not include specific information pertaining to your specific application. These instructions are written assuming the use of Multi-Point Electronic Fuel Injection using a standard return (bypass) style fuel pressure regulator. This Fuel Pump may be integrated in some returnless EFI or general carbureted systems. Visit our company website for specific details pertaining to example fuel systems and other solution ideas. Additional information including advanced troubleshooting, any special alerts and FAQ's pertaining to this and other products is also available. A good design plan for the fuel system must contain consideration for: Pressure and flow rate through various components, quality of components, operating environment (temperature, vibration, shock, general exposure to elements) and local area laws. Begin installation of Fuel Pump only after a complete plan is established to help avoid fuel system component failure, costly rework, and excessive installation time.

Plumbing Planning Notes:

Fuel Pump must be mounted inside a fuel tank or cell. This Power Module is required to be used with a Fuelab Power Module Installation Kit, such as the Fabricator's Kit per Model 20901 (supplied separately). Follow all instructions provided with the Power Module Installation Kit to be used with this product. Follow all instructions included herein. Do not use "cross drilled" style 90° elbow fittings, check valves or other restrictions (other than high flow fuel filter strainer supplied with Power Module Installation Kit) before or upstream of Fuel Pump. Typically -6AN (3/8") to -10AN (5/8") line is required for the fuel system, after or downstream of Fuel Pump. Use of the Strainer Filter as supplied from the Power Module Installation Kit (supplied separately) upstream of Fuel Pump is required to protect Fuel Pump from damage. All fuel line used must handle high pressure. The use of fuel line such as stainless steel braided line and "AN" style fitting connections is recommended. The fuel port (one -8AN Outlet Port) uses "AN" or "military" style fittings. This plumbing standard is commonly used with racing and high performance applications. See step 4 on page 5 for additional information on this port standard. A fuel filter with a 60 micron or lower particle rating is required to be used upstream of regulator and downstream from Fuel Pump to protect it and the fuel injectors from foreign object damage. Reference the Schematic Diagram below for component locations. Fuel tank may have to be modified or be specific in application for use with the Fuelab Power Module Installation Kit (supplied separately). This Fuel Pump has two Auxiliary Outlet Ports that can be used for either relief (within fuel tank) or for Jet Pump (Eductor) use. Plug all unused Auxiliary Outlet Ports. Use of a liquid filled gauge exposed to engine compartment heat is not recommended as the liquid inside the gauge may exert measurement errors, all mechanical gauges and pressure transducers have amounts of error due to temperature fluctuation, be aware of inaccurate pressure readings. **DO NOT** plumb gauge port to any gauge mounted inside the vehicle or in passenger compartment. A line burst can spill fuel inside passenger compartment and on occupants, possibly causing serious injury or death. An electronic gauge or pressure transducer system is recommended for readings in a passenger compartment.

Typical EFI V-8 Fuel System Plumbing Schematic Diagram:

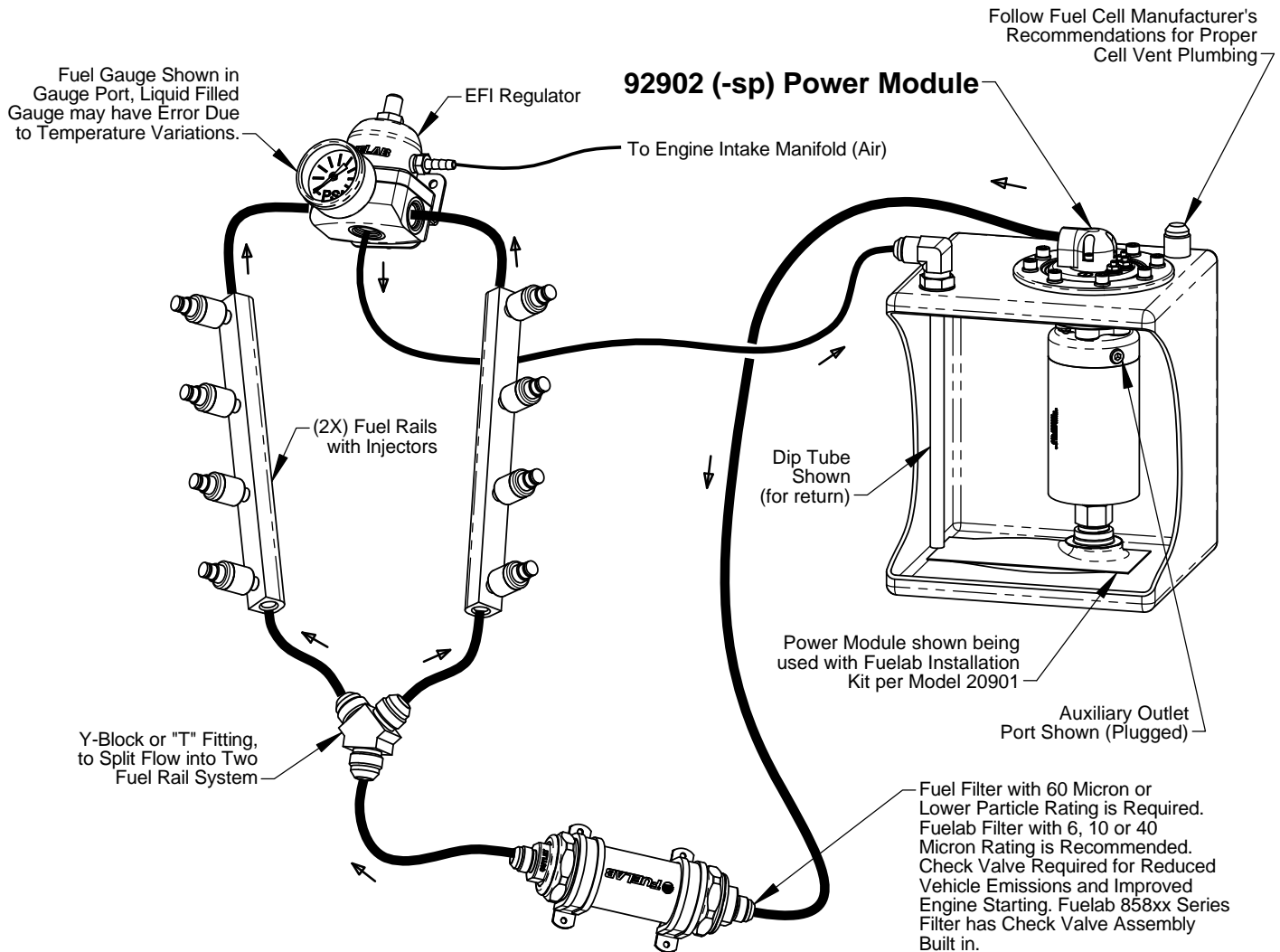

Special Note: Use in carbureted systems require a bypass return or relief valve. Do Not "Dead Head" Fuel Pump.

Electrical Planning Notes:

Reference Sheets 3 and 4 for schematic wiring diagram examples. Use electrical components as described including electrical connectors that are appropriate for the operating environment of the fuel system, whether its use in street, racing, or marine applications. Electrical connectors for the power leads must be capable of high current draw, note all connections, wire and component rating requirements herein. Solder and use shrink wrap for wire splices for extra reliability. Use of a check valve in fuel system as shown in plumbing diagram will maintain fuel pressure at normal levels during engine starting and may be required depending on the wiring of main relay control circuit. OEM and some aftermarket ECMs have fuel pump relay control outputs can be used that will turn off Fuel Pump during engine starting, requiring check valve use. If the fuel pressure does not maintain during engine starting, ensure Fuel Pump is energized while starting. Main wiring schematic diagram, below shows the control of relay by ignition switch. This source can be changed as described, or by a toggle switch. Some forms of racing have specific rules regarding electrical switching of Fuel Pump. Consult appropriate racing guidelines, rules and regulations.

MAIN WIRING SCHEMATIC DIAGRAM: (Electrical components shown are not supplied with Fuel Pump)

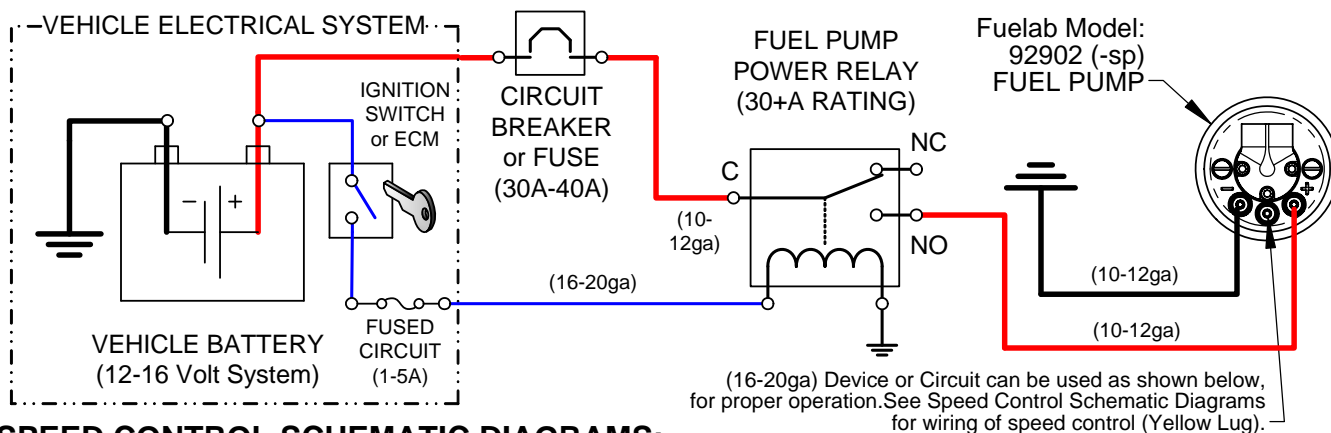

SPEED CONTROL SCHEMATIC DIAGRAMS:

The speed control terminal (Yellow Center Lug) can have voltage or a signal applied to it. When the speed control terminal has less than 1/4V (Approx) applied to it, the mode of operation is in continuous reduced speed. When the speed control terminal has greater than 2.5V (Approx), the mode of operation is in continuous maximum speed. A pulsed signal may also be used to control pump speed. See examples below for a method suitable for your application.

Example 1: Continuous Maximum Speed

Attach no wiring to speed control terminal, to operate pump at continuous maximum speed. The performance curve was recorded as shown on the Pump Certification as "Maximum Speed". Use Example 1 for racing specific applications, or short interval use. Use in continuous maximum speed may cause over-heating and therefore may damage fuel pump. Additional cooling may be required using maximum speed only while operating with low engine demand for extended periods.

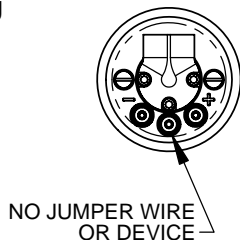

Example 2: Continuous Reduced Speed

Attach a jumper wire as shown below, to operate pump at continuous reduced speed. The reduced speed is preset, with the performance curve shown on the pump certification. See schematic, attach wire between negative terminal (Black Lug) and Yellow Lug. Use Example 2 if the flow rate at reduced speed is adequate for application. Using this mode of operation is considered continuous duty. See Examples 3 and 4 for switching between maximum and reduced speed.

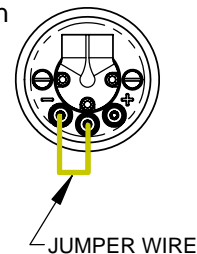

Example 3: Switch to Ground Speed Changing

Attach switch and wiring as shown to the right, to operate pump at continuous maximum speed while switch is in the open position (position as shown in diagram). When the switch is in the closed position (on), the pump will operate in reduced speed mode. To reverse the desired switch action, refer to Example 4. Switch type can be a relay or switching based on pressure or other means. Current draw through this circuit is extremely low (much less than 1 amp), so a very low current rating for this switch can be used. Use the diagram to the right as a guide to properly wire this example. Reduced speed is recommended during long periods of low engine fuel demand conditions to avoid fuel system heat build-up.

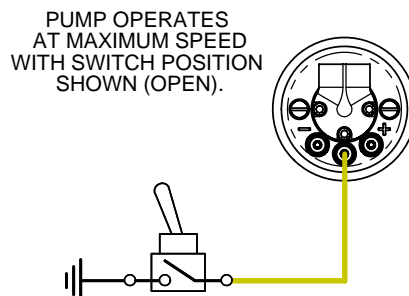

SPEED CONTROL SCHEMATIC DIAGRAMS: (cont.)

Example 4: Switch to Power Speed Changing

When the switching action is in reverse to what can be used as shown Example 3, such as some pressure switches, the action can be reversed through the use of a Single Pole Dual Throw (SPDT) relay as shown to the right. Current draw through this circuit is extremely low (much less than 1 amp), so a very low current rating for this 12 volt relay and switch can be used. Use the diagram to the right as a guide to properly wire this example. Reduced speed is recommended during long periods of low engine fuel demand conditions to avoid fuel system heat build-up.

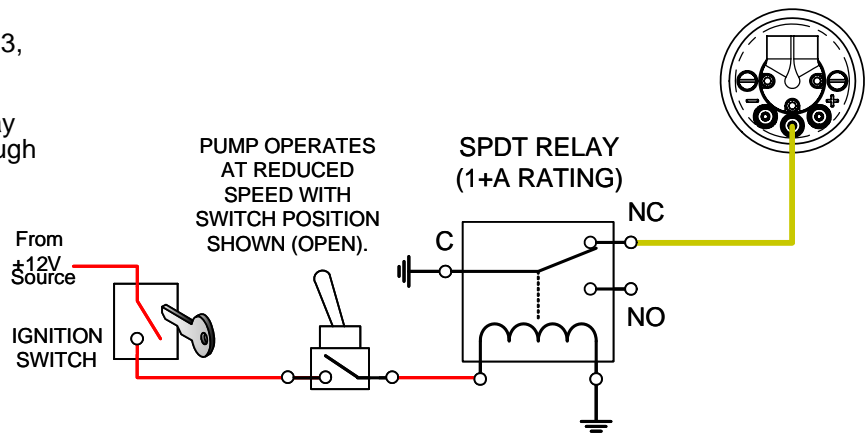

Example 5: Variable Speed

Devices such as an aftermarket ECM can create a pulsed signal ("pulling" voltage to ground at a given frequency). This signal has a characteristic of dwell time, which is a ratio of on-time vs. off-time (in other words, the amount of time the signal is at vehicle voltage vs. at zero voltage). This difference in dwell time percentage will enable the fuel pump to operate at various speeds or flow rate. A graph demonstrating an example signal created by such a device is shown below. The example signal is at 50% duty cycle, whereas the amount time that the signal is at vehicle voltage is equal to the amount of time at zero volts. When duty cycle is between 0-20%, the fuel pump is turned off. A duty cycle between 20%-90% will be variable speed between minimum and maximum speeds, while duty cycles between 90% and 100% are maximum Speed.

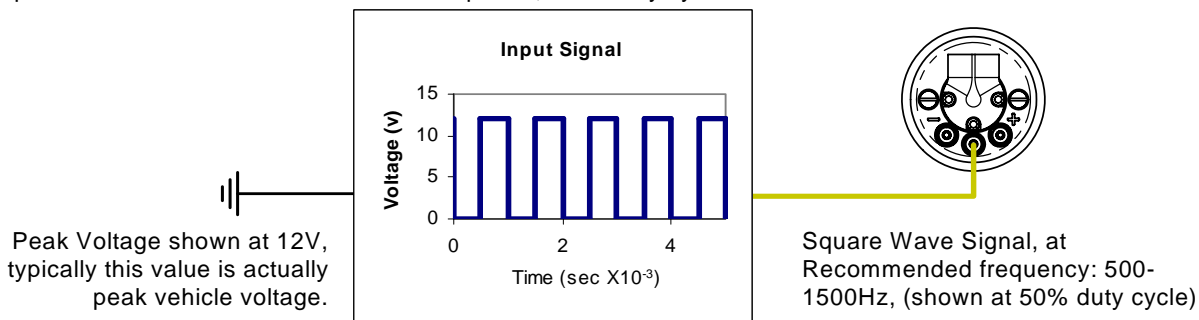

Refer to above Example 5, for use with the Fuelab Electronic Fuel Pressure Regulator, Models 52901 and 52902, that creates its own pulsed signal. These regulators automatically control the Fuel Pump, without the use of switching means or other components such as described in examples 2 and 3. Refer to instructions for the Electronic Regulator, for proper wiring and installation.

TROUBLESHOOTING:

Problem	Possible Cause	Possible Solution
Not operating or slight "clicking" sound when turned on.	<ul style="list-style-type: none"> Faulty fuel pump relay. Faulty, dirty or corroded terminals or improperly sized wire. Debris from tank or plumbing lodged inside pump. 	Check voltage to fuel pump, at power terminals. If voltage is steady and consistent (within ½ Volt of battery) then contact Fuelab for repair. If voltage is inconsistent as described, repair or replace electrical components as required.
Speed of pump changes up and down very noticeably and erratically.	<ul style="list-style-type: none"> Incorrect wiring of speed control as specified in wiring Examples 1 through 5. Loose terminal or wiring of speed control circuit. 	Unhook speed control wiring from yellow terminal of pump. Turn on pump; if operation is consistent, then repair or replace components as required.
Loss of fuel pressure or erratic pressure pulsation after several minutes of operation.	<ul style="list-style-type: none"> Cavitation (vapor lock) due to overheating or restricted inlet. 	Check temperature of pump right after failure. If pump is hot to touch (cannot leave hand on pump due to it being too hot), then follow proper speed control wiring example, or look for other sources of heat such as exhaust. If pump is not hot to the touch, check for inlet restrictions such as improperly vented tank, kinks in the fuel line, or too small of plumbing for application. Contact Fuelab, as pump may be damaged due to improper operating condition.

TROUBLESHOOTING: (cont.)

Problem	Possible Cause	Possible Solution
Not building up fuel pressure.	<ul style="list-style-type: none"> Incorrect fuel system initial priming procedure. Loose inlet fuel fittings or leaking plumbing on inlet side. 	Repeat procedure for proper priming. If condition continues, check all plumbing upstream (on inlet side) of fuel pump.
Fuel pressure drops off under heavy engine load, particularly in higher gears.	<ul style="list-style-type: none"> Incorrect wiring of speed control as specified in wiring Examples 1 through 5. Loose terminal or wiring. Insufficient fuel capacity. 	Make sure pump is operating at full speed while under high engine load. If condition continues, upgraded pump capacity is required.
Leakage of fuel at inlet or outlet fuel ports.	<ul style="list-style-type: none"> Improper type of fitting used. 	If leakage is occurring between end caps of pump and sleeve of pump, contact Fuelab immediately for repair or replacement. If leakage occurs at fitting, be sure that the proper fitting style is used (AN o-ring seal type ONLY!). Pipe threaded style fittings are NOT to be used.

Installation Steps:

1. Disconnect the ground terminal from battery and allow the vehicle's engine and exhaust system to cool. Relieve fuel system pressure per applicable service manual. Follow all Warnings, Cautions and Instructions written on previous pages of these instructions.
2. Modify, remove or replace other fuel system components as required per established build plan (reference notes on previous pages and above).
3. Follow all instructions regarding the installation of the Power Module Installation Kit. Every Power Module requires the use of an installation kit (supplied separately), to provide a means of mounting as well as a means of plumbing a straining filter.
4. Install the outlet fuel fitting (not supplied). The threads used on this Fuel Port are not tapered or pipe threads. Do not use Teflon, thread tape or thread sealant on these threads, as this can cause leakage or introduce debris into the fuel system. Fittings to be used with these style of ports require the use of the included -908 O-ring for proper sealing. Use light oil to lubricate the O-ring just prior to installation. Install the O-ring onto the fuel fitting first. Position the O-ring in the thread relief of the fitting. Thread fitting into outlet and tighten between 5 and 15 ft•lbs of torque.
5. Inspect fuel system for any contact of fuel lines or wires with other components that can cause chafing or rubbing. Secure all components and fuel lines. Ensure that moving components of vehicle are clear.
6. Connect the vehicle's battery. Perform initial priming: The Fuel Pump may require priming during initial operation and for possible moments after depletion of fuel from fuel tank or cell. This action can be accomplished by removing fuel line from fuel rail (downstream of Fuel Pump and filters), allowing the fuel line to empty fluid into fuel safe container. Operate Fuel Pump until fuel exits fuel line. Attach fuel line back to the fuel rail after priming fuel pump. After tightening connection, verify leak-free operation while checking fuel rail pressure. If fuel pressure is not high enough, repeat priming procedure to ensure that Fuel Pump is receiving fuel from tank. Turn on Fuel Pump (typically by bypassing fuel pump relay) without engine operating. ECU or engine management computer may be controlling the relay. The ECU may only operate pump for a few seconds each time ignition switch is set to on. The Fuel Pump will have to operate several seconds (30+) to prime and drive air out of the fuel system. Reattach fuel rail line. Start fuel system and inspect for leaks. Fuel system pressure should read about 20-25 PSIG (depends on regulator used, use an external gauge for adjustment if a permanent gauge is not used). Inspect vehicle for any leaks. Turn off fuel system and repair any leaks that may be present before continuing.
7. When adjusting pressure, be sure that Fuel Pump is operating to monitor pressure. Fuelab recommends to use a "baseline" pressure reference when adjusting the pressure (adjusting the pressure with engine off or Pressure Reference Line unhooked). The vehicle's engine may not produce consistent vacuum during idle to have repeatable readings.
8. After final adjustment of fuel pressure, tighten Jam Nut. Road test vehicle, and retest pressure upon return to ensure accurate adjustment. After installation of this fuel pump, verify flow capacity to ensure safe levels of flow, particularly with reduced levels of pump speed. Having insufficient flow capacity can result in an engine lean-out condition that can cause severe engine damage. Collecting a given amount of fuel (as measured by weight or volume) over a measured amount of time can be used to determine capacity. Collect fuel flow from the return line to measure the amount of fuel capacity at a given operating pressure. A 20+ ampere capacity battery charger may be used to simulate the charging system of the vehicle while engine is off. If using an adjustable fuel pressure regulator, for boosted applications, simulate boost by raising the fuel pressure by the amount of expected maximum boost pressure. Performing these tests will give greater accuracy for capacity tests.

LIMITED WARRANTY

FUELAB, a division of FCP, Inc., having its principal place of business at **1605 Eastport Plaza Drive, Suite 125, Collinsville, IL 62234, USA** ("Manufacturer") warrants its **FUELAB** products (the "Products") as follows:

1. Limited Warranty.

Manufacturer warrants that the Products sold hereunder will be free from defects in material and workmanship for a period of 2 Years from the date of purchase to the original purchaser. If the Products do not conform to this Limited Warranty during the warranty period (as herein above specified), Buyer shall notify Manufacturer in writing, or by phone, of the claimed defects and demonstrate to Manufacturer satisfaction that said defects are covered by this Limited Warranty. If the defects are properly reported to Manufacturer within the warranty period, and the defects are of such type and nature as to be covered by this warranty, Manufacturer shall, at its own expense, furnish replacement Products or, at Manufacturer's option, replacement parts for the defective Products. Removal of Products from vehicle (*Vehicle means any automotive, bike or marine transportation powered by an internal combustion engine. This product is **NOT** intended or designed for use on aircraft, experimental or otherwise.*), shipping to Manufacturer and installation of the replacement Products or replacement parts shall be at Buyer's expense.

2. Other Limits.

THE FOREGOING IS IN LIEU OF ALL OTHER WARRANTIES, EXPRESS OR IMPLIED, INCLUDING BUT NOT LIMITED TO THE IMPLIED WARRANTIES OF MERCHANTABILITY AND FITNESS FOR A PARTICULAR PURPOSE. Manufacturer does not warrant against damages or defects arising out of improper or abnormal use or handling of the Products; against defects or damages arising from improper installation (where installation is by persons other than Manufacturer), against defects in products or components not manufactured by Manufacturer, or against damages resulting from such non-Manufacturer made products or components. Manufacturer passes on to Buyer the warranty it received (if any) from the maker thereof of such non-Manufacturer made products or components. This warranty also does not apply to Products upon which repairs have been effected or attempted by persons other than pursuant to written authorization by Manufacturer.

3. Exclusive Obligation.

THIS WARRANTY IS EXCLUSIVE. The sole and exclusive obligation of Manufacturer shall be to repair or replace the defective Products in the manner and for the period provided above. Manufacturer shall not have any other obligation with respect to the Products or any part thereof, whether based on contract, tort, strict liability or otherwise. Under no circumstances, whether based on this Limited Warranty or otherwise, shall Manufacturer be liable for incidental, special, or consequential damages.

4. Other Statements.

Manufacturer's employees, representatives' and/or resellers ORAL OR OTHER WRITTEN STATEMENTS DO NOT CONSTITUTE WARRANTIES, shall not be relied upon by Buyer, and are not a part of the contract for sale or this limited warranty.

5. Entire Obligation.

This Limited Warranty states the entire obligation of Manufacturer with respect to the Products. If any part of this Limited Warranty is determined to be void or illegal, the remainder shall remain in full force and effect.

6. Warranty Service

What Does This Warranty Not Cover? Any problem that is caused by abuse, misuse, or an act of God (such as a flood) is not covered. Also, consequential and incidental damages are not recoverable under this warranty. Some states do not allow the exclusion or limitation of incidental or consequential damages, so the above limitation or exclusion may not apply to you.

How Do You Get Service? In order to be eligible for service under this warranty you **MUST** return the Warranty Registration card, or register on-line at www.fuelab.com/warranty within 30 days of purchasing the Product.

If something goes wrong with your product contact FUELAB at 1-800-541-2345, International customers call 001-217-324-3737, for a Return Authorization Number (RMA). After receiving your RMA send it postage paid, fully insured, with a brief written description of the problem to:

FUELAB Warranty Department, 1605 Eastport Plaza Drive, Suite 125, Collinsville, IL 62234

We will inspect your Product and contact you within 72 hours of receipt to give the results of our inspection and an estimate of the labor and/or parts charges required to fix the Product, if applicable. If covered under this limited warranty Manufacturer will repair Product and return it to you at no cost. If the Product is NOT covered under this warranty and if you authorize repairs, we will return the repaired Product to you COD, or prepaid via credit card, within 72 hours. There is no charge for inspection. If return product is found to be free of defects a \$25.00 shipping and handling charge will be applied. We will return the repaired Product to you COD, or prepaid via credit card, within 72 hours.